

## Trench Field-Stop Technology IGBT

### Features

- 1200V, 15A
- $V_{CE(sat)(typ.)} = 2.00V @ V_{GE}=15V, I_C=15A$
- Low Switching Losses
- $V_{CE(sat)}$  with Positive Temperature Coefficient
- Pb-free Lead Plating; RoHS Compliant

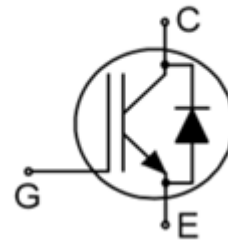

### Applications

- Frequency Converters
- Uninterrupted Power Supply
- Air Conditioning
- Motor Drives

Order codes	$V_{CE}$	$I_C$	$V_{CEsat}, T_{vj}=25^{\circ}C$	$T_{vjmax}$	Marking	Package
XD015H120CX1S3	1200V	15A	2.0V	175 $^{\circ}C$	D15H120CX1	TO247

### Absolute Maximum Ratings

Symbol	Parameter	Value	Unit
$V_{CES}$	Collector-Emitter Voltage	1200	V
$V_{GES}$	Gate-Emitter Voltage	$\pm 20$	V
$I_C$	Continuous Collector Current ( $T_C=25^{\circ}C$ )	30	A
	Continuous Collector Current ( $T_C=100^{\circ}C$ )	15	A
$I_{CM}$	Pulsed Collector Current (Note 1)	45	A
$I_F$	Diode Continuous Forward Current ( $T_C=100^{\circ}C$ )	15	A
$I_{FM}$	Diode Maximum Forward Current (Note 1)	45	A
$t_{sc}$	Short Circuit Withstand Time	10	us
$P_D$	Maximum Power Dissipation ( $T_C=25^{\circ}C$ )	245	W
	Maximum Power Dissipation ( $T_C=100^{\circ}C$ )	122	W
$T_J$	Operating Junction Temperature Range	-40 to 175	$^{\circ}C$
$T_{STG}$	Storage Temperature Range	-55 to 150	$^{\circ}C$

### Thermal Data

Symbol	Parameter	Max.	Unit
$R_{\theta JC}$	Thermal Resistance, Junction to Case for IGBT	0.61	$^{\circ}C/W$
$R_{\theta JC}$	Thermal Resistance, Junction to Case for Diode	0.77	$^{\circ}C/W$
$R_{\theta JA}$	Thermal Resistance, Junction to Ambient	40	$^{\circ}C/W$

**Electrical Characteristics** ( $T_c=25^\circ\text{C}$  unless otherwise noted)

Symbol	Parameter	Conditions	Min.	Typ.	Max.	Unit
$BV_{CES}$	Collector-Emitter Breakdown Voltage	$V_{GE}=0V, I_C=500\mu A$	1200	---	---	V
$I_{CES}$	Collector-Emitter Leakage Current	$V_{CE}=1200V, V_{GE}=0V$	---	---	1	mA
$I_{GES}$	Gate Leakage Current, Forward	$V_{GE}=20V, V_{CE}=0V$	---	---	400	nA
	Gate Leakage Current, Reverse	$V_{GE}=-20V, V_{CE}=0V$	---	---	-400	nA
$V_{GE(th)}$	Gate Threshold Voltage	$V_{GE}=V_{CE}, I_C=480\mu A$	5.2	5.8	6.4	V
$V_{CE(sat)}$	Collector-Emitter Saturation Voltage	$V_{GE}=15V, I_C=15A$	---	2.0	2.3	V
$Q_G$	Total Gate Charge	$V_{CC}=960V$	---	68	---	nC
$Q_{GE}$	Gate-Emitter Charge	$V_{GE}=15V$	---	12.8	---	nC
$Q_{GC}$	Gate-Collector Charge	$I_C=15A$	---	50.2	---	nC
$t_{d(on)}$	Turn-on Delay Time	$V_{CC}=600V$ $V_{GE}=\pm 15V$ $I_C=15A$ $R_G=39\Omega$ Inductive Load $T_C=25^\circ\text{C}$	---	36	---	ns
$t_r$	Turn-on Rise Time		---	28	---	ns
$t_{d(off)}$	Turn-off Delay Time		---	215	---	ns
$t_f$	Turn-off Fall Time		---	226	---	ns
$E_{on}$	Turn-on Switching Loss		---	1.62	---	mJ
$E_{off}$	Turn-off Switching Loss		---	1.11	---	mJ
$E_{ts}$	Total Switching Loss		---	2.73	---	mJ
$C_{ies}$	Input Capacitance	$V_{CE}=25V$	---	903	---	pF
$C_{oes}$	Output Capacitance	$V_{GE}=0V$	---	94	---	pF
$C_{res}$	Reverse Transfer Capacitance	$f = 1\text{MHz}$	---	48	---	pF

**Diode Characteristics** ( $T_C=25^\circ\text{C}$  unless otherwise noted)

Symbol	Parameter	Conditions	Min.	Typ.	Max.	Unit
$V_F$	Diode Forward Voltage	$I_F=15A$	---	2.6	3.2	V
$t_{rr}$	Diode Reverse Recovery Time	$V_{CE}=600V$ $I_F=15A$ $di_F/dt=450A/\mu s$	---	131.5	---	ns
$I_{rr}$	Diode Peak Reverse Recovery Current		---	7.2	---	A
$Q_{rr}$	Diode Reverse Recovery Charge		---	466	---	nC

Note 1: Repetitive Rating: Pulse width limited by maximum junction temperature

## Typical Characteristics

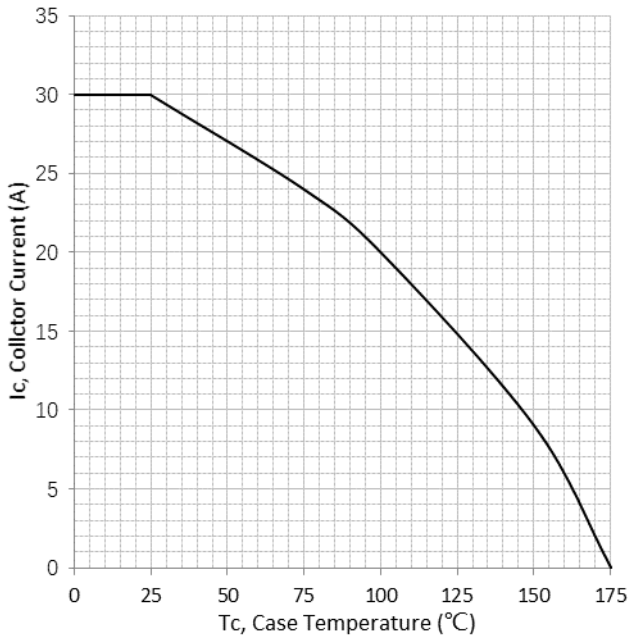

**Fig. 1 Maximum DC Collector Current vs. Case Temperature**

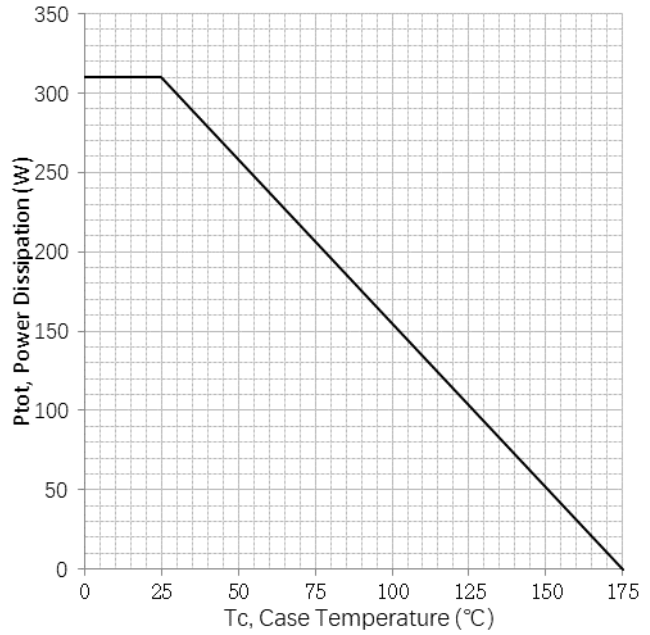

**Fig. 2 Power Dissipation vs. Case Temperature**

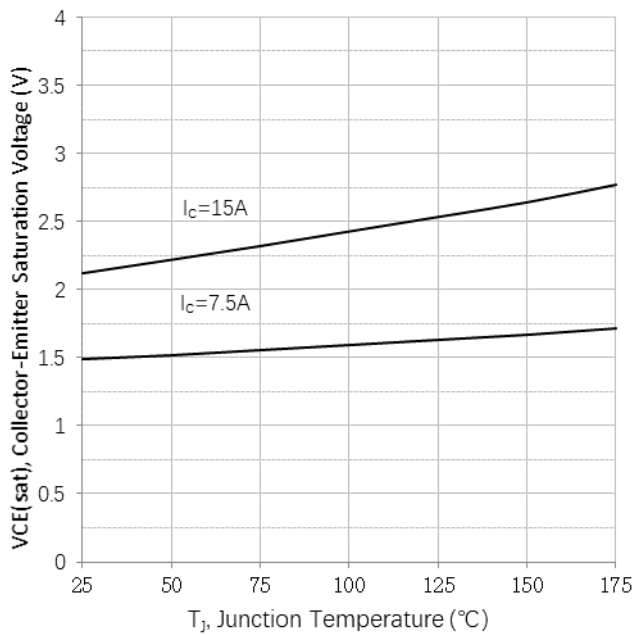

**Fig. 3 Typical Collector-Emitter Saturation Voltage vs. Junction Temperature ( $V_{GE}=15V$ )**

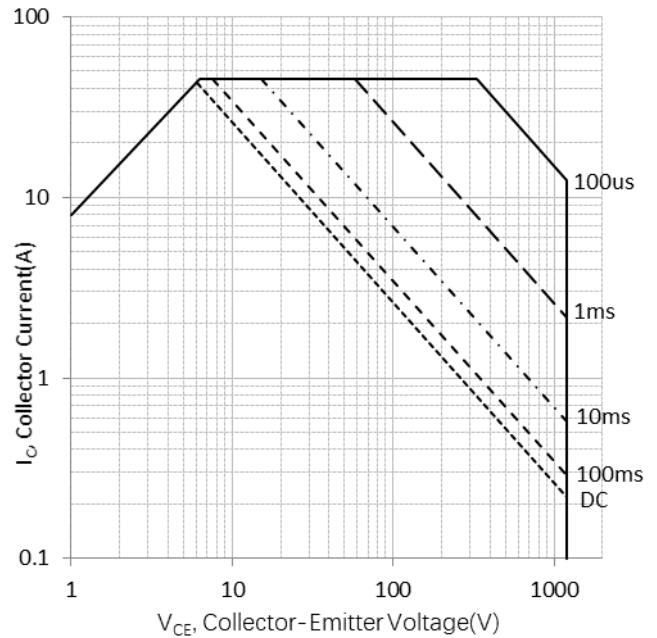

**Fig. 4 Safe Operating Area at  $T_c=25°C$  and  $T_j \leq 175°C$**

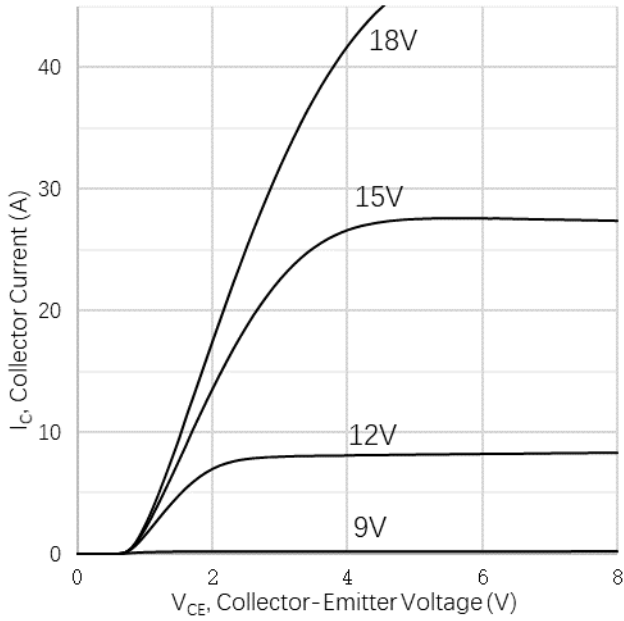

**Fig. 5 Typical IGBT Output Characteristics at  $T_J=25^\circ\text{C}$**

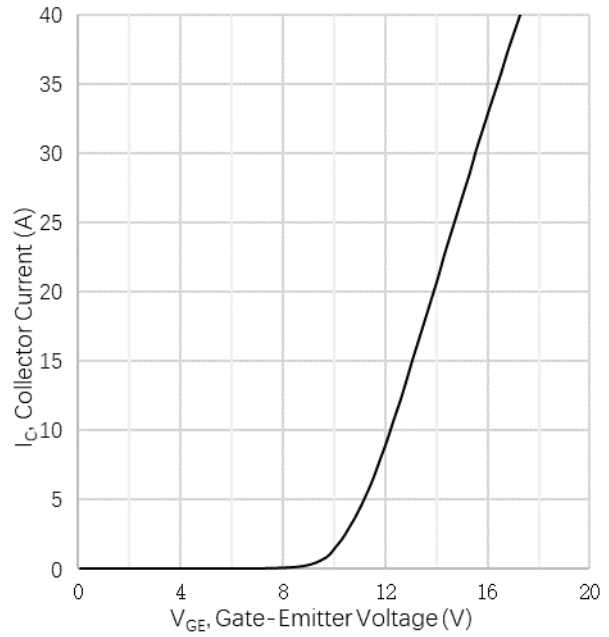

**Fig. 6 Typical Transfer Characteristics at  $V_{CE}=20\text{V}$**

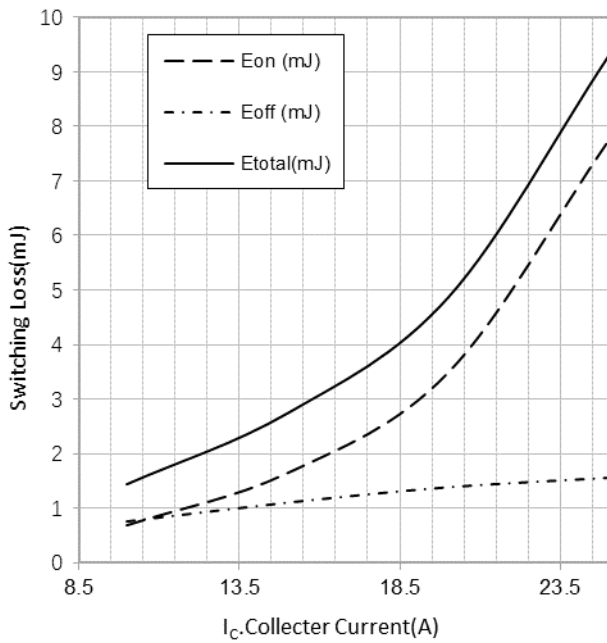

**Fig. 7 Typical Energy Loss vs.  $I_C$  at  $T_C=25^\circ\text{C}$ ,  $V_{CE}=600\text{V}$ ,  $V_{GE}=\pm 15\text{V}$  and  $R_g=39\Omega$**

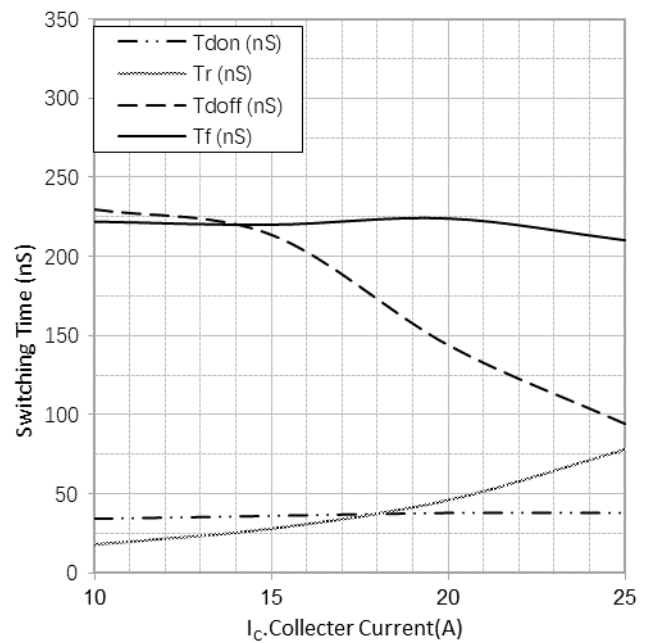

**Fig. 8 Typical Switching Time vs.  $I_C$  at  $T_C=25^\circ\text{C}$ ,  $V_{CE}=600\text{V}$ ,  $V_{GE}=\pm 15\text{V}$  and  $R_g=39\Omega$**

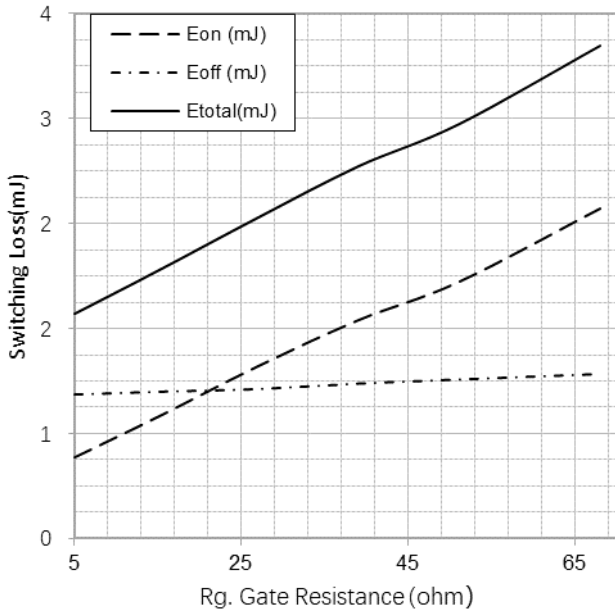

**Fig. 9 Typical Energy Loss vs. Rg at  $T_C=25^\circ\text{C}$ ,  
 $V_{CE}=600\text{V}$ ,  $V_{GE}=15\text{V}$ ,  $I_C=15\text{A}$  and  $R_g=39\Omega$**

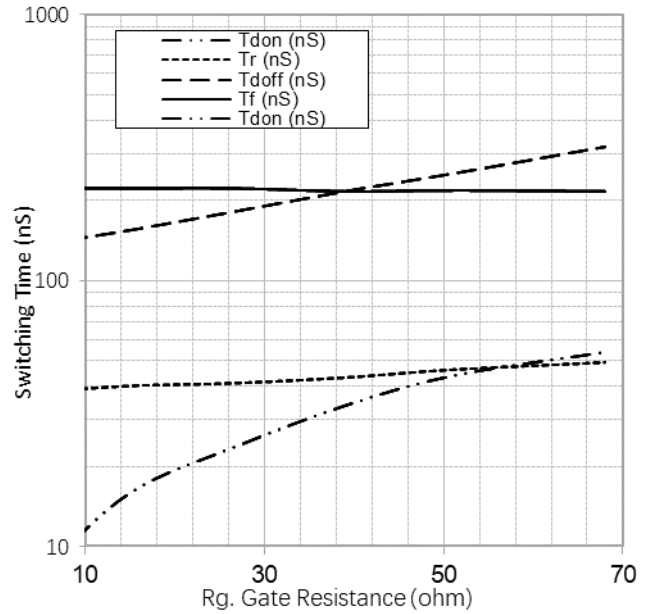

**Fig. 10 Typical Switching Time vs. Rg at  $T_C=25^\circ\text{C}$ ,  
 $V_{CE}=600\text{V}$ ,  $V_{GE}=15\text{V}$ ,  $I_C=15\text{A}$  and  $R_g=39\Omega$**

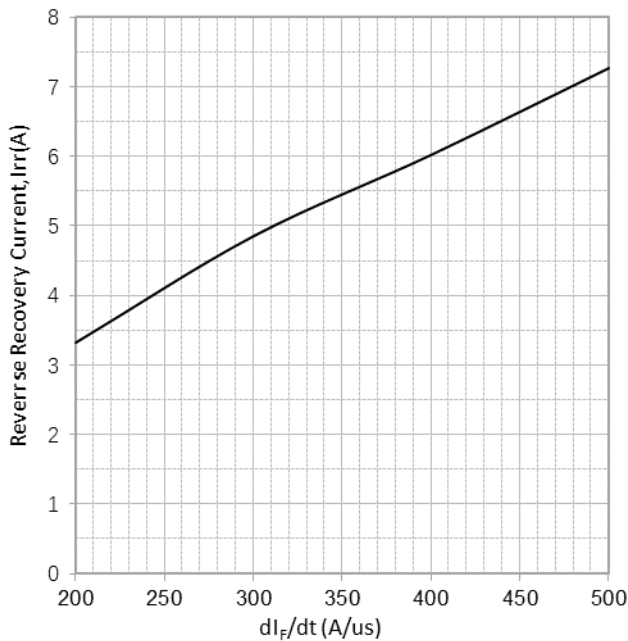

**Fig. 11 Typical Diode Irr vs.  $di_F/dt$  at  $V_{CC}=600\text{V}$  and  
 $V_F=15\text{A}$**

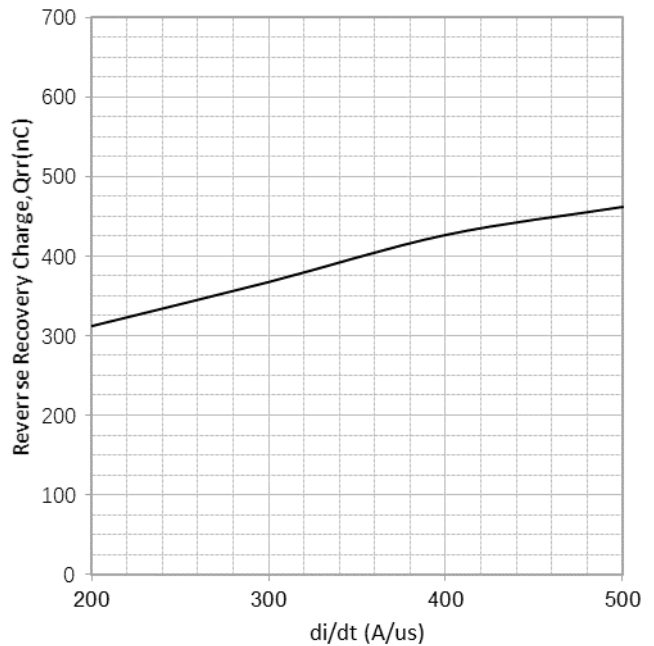

**Fig. 12 Typical Diode Qrr vs.  $di/dt$  at  $V_{CC}=600\text{V}$  and  
 $V_F=15\text{A}$**

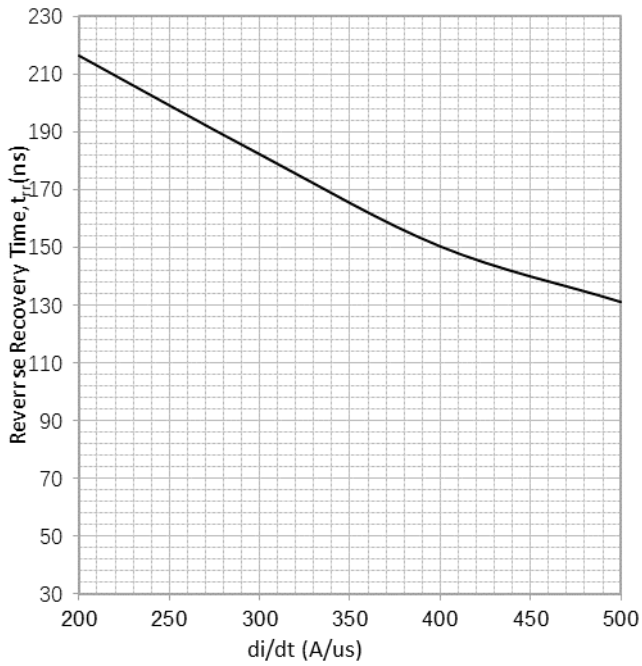

Fig. 13 Typical Diode  $t_{rr}$  vs.  $di/dt$  at  $V_{CC}=600V$  and  $V_F=15A$

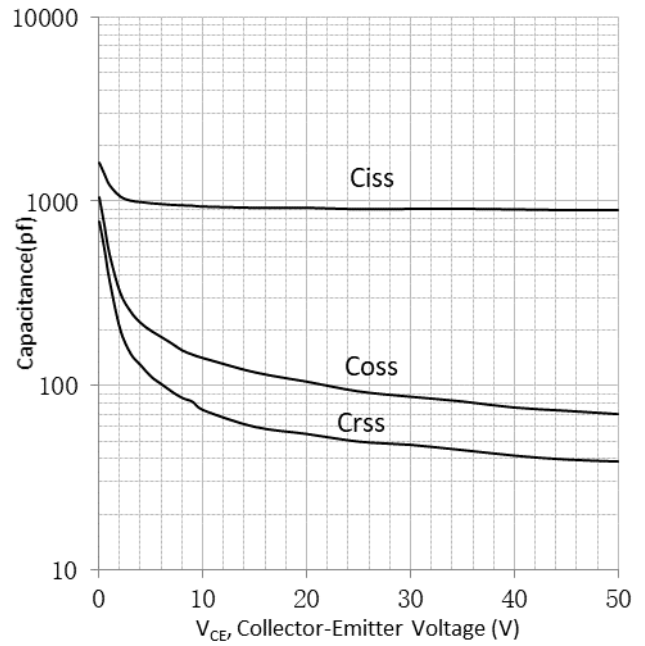

Fig. 14 Typical Capacitance vs.  $V_{CE}$  at  $V_{GE}=0V$  and  $f=1MHz$

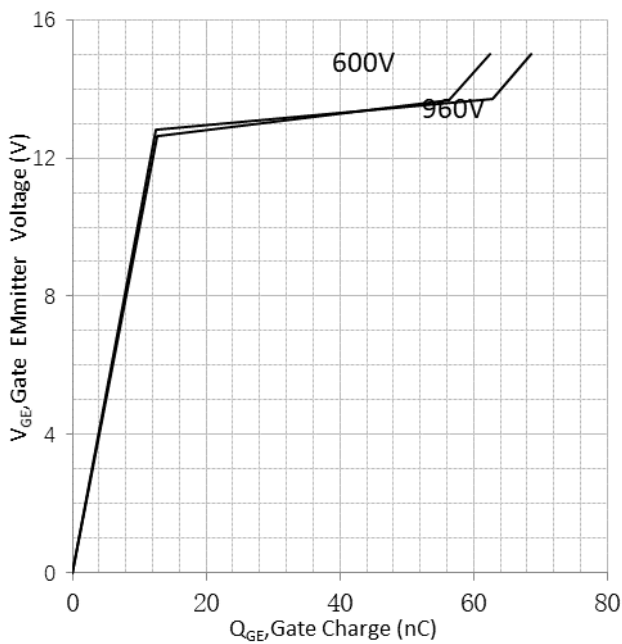

Fig. 15 Typical Gate Charge vs.  $V_{GE}$  at  $I_C=15A$

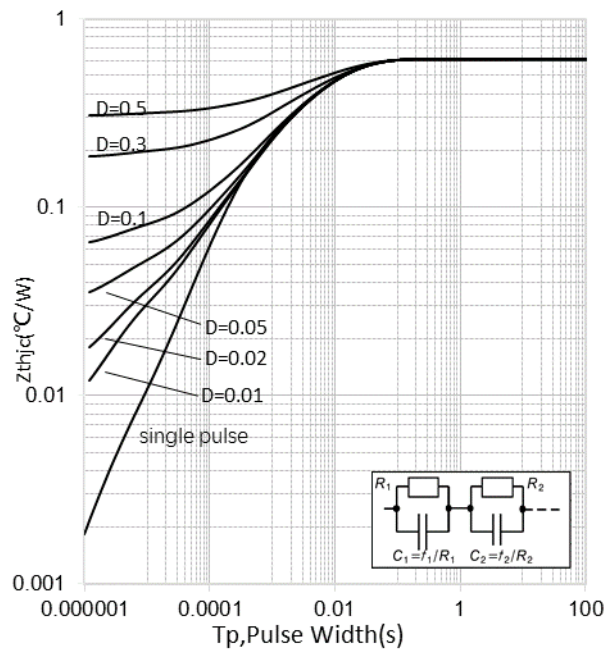
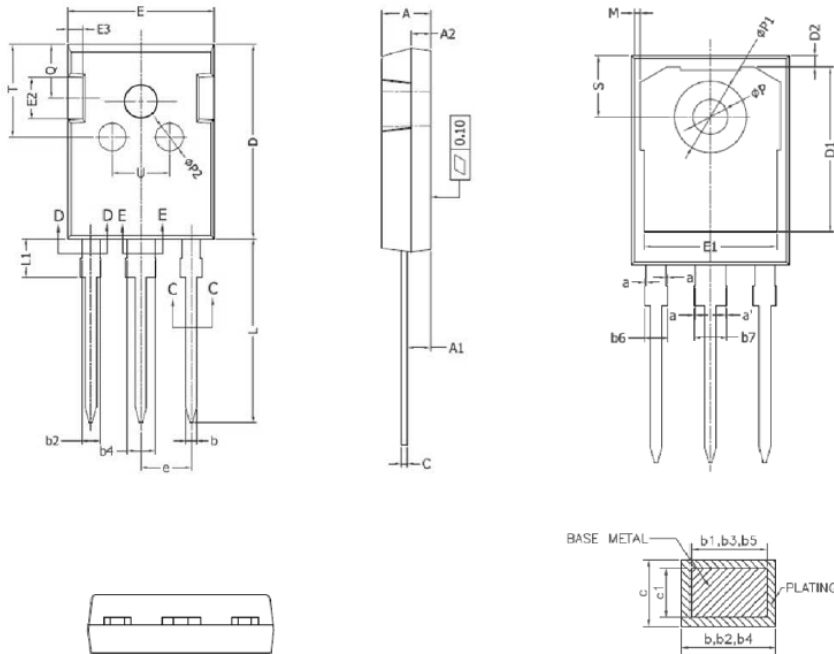

Fig. 16 IGBT Transient Thermal Resistance ( $D=t_p / T$ )

# Package Information

TO-247



COMMON DIMENSIONS  
(UNITS OF MEASURE =MILLIMETER)

SYMBOL	MIN	NOM	MAX
A	4.90	5.00	5.10
A1	2.31	2.41	2.51
A2	1.90	2.00	2.10
a	0	---	0.15
a'	0	---	0.15
b	1.16	---	1.26
b1	1.15	1.2	1.22
b2	1.96	---	2.06
b3	1.95	2.00	2.02
b4	2.96	---	3.06
b5	2.96	3.00	3.02
b6	---	---	2.25
b7	---	---	3.25
c	0.59	---	0.66
c1	0.58	0.60	0.62
D	20.90	21.00	21.10
D1	16.25	16.55	16.85
D2	1.05	1.17	1.35
E	15.70	15.80	15.90
E1	13.10	13.30	13.50
E2	4.40	4.50	4.60
E3	1.50	1.60	1.70
e	5.436 BSC		
L	19.80	19.92	20.10
L1	---	---	4.30
M	0.35	---	0.95
P	3.40	3.50	3.60
P1	7.00	---	7.40
P2	2.40	2.50	2.60
Q	5.60	---	6.00
S	6.05	6.15	6.25
T	9.80	---	10.20
U	6.00	---	6.40

NOTES:  
ALL DIMENSIONS REFER TO JEDEC STANDARD TO-247 AND DO NOT INCLUDE MOLD FLASH OR PROTRUSIONS.  
EJECTION MARK DEPTH  $0.10^{+0.15}_{-0.10}$

## Revision History

Ver.	Date	Change Notice
1.0	2020/10/11	Released
1.1	2021/06/23	Add Marking information